

Referans Nr.	d	D (h6)	H	(kg)
0950-08001D	8.5	12	15	7
0950-12001D	12.5	18	22	22

Ürün Nr. 0956 5-Eksen Blok Bağlama Konumlama Burcu
 • Tolerans ± 0.02

Product Nr. 0956 5-Axis Clamping Block Locating Bushings
 • Tolerance ± 0.02

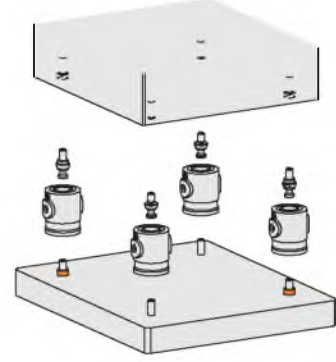
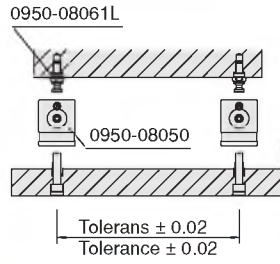
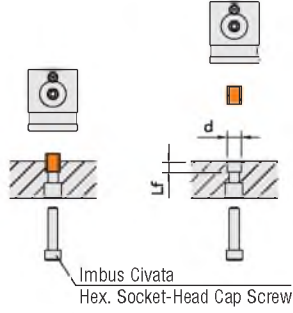
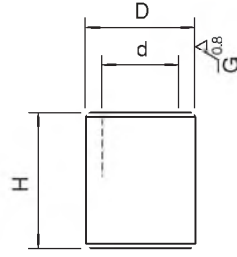

Referans Nr.	d (H7)	Lf
0950-08001D	12	8.5
0950-12001D	18	12.5

5-Eksen Blok Bağlama Konumlama Burcu

5-Axis Clamping Block Locating Bushings

Referans Nr.	D	H	D1	H1	d	(g)	
0950-08001LS	15.5	10	12	g6	5	8	6
0950-12001LS	24.5	12	18	g6	6	12	24
0950-08001SM	15.5	12	12	-0.02	5	-	11
0950-12001SM	24.5	18	18	-0.05	6	-	37

Ürün Nr. 0958 5-Eksen Blok Bağlama Konumlama Burcu
 • Taşlanmış Tolerans ± 0.02
 • Standart Tolerans $^{+0.1}_0$

Product Nr. 0958 5-Axis Clamping Block Locating Bushings
 • Stoning Tolerans ± 0.02
 • Standard Tolerance $^{+0.1}_0$

Uygulama Örneği / Application Example

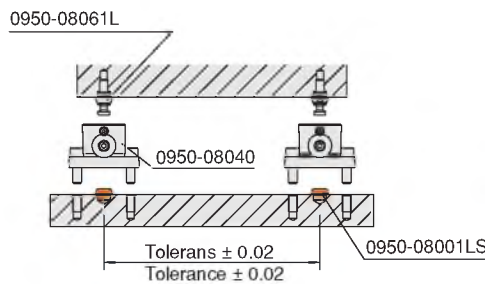
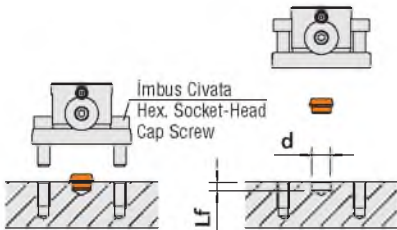

Referans Nr.	d (H7)	Lf
0950-08001LS	12	5.5
0950-12001LS	18	6.5



LS
Taşlanmış
Stoning



SM
Standart
Standard

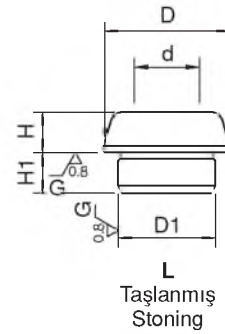

L
Taşlanmış
Stoning

