

ER 11 PENSLER

DIN 6499 / ISO 15488-B

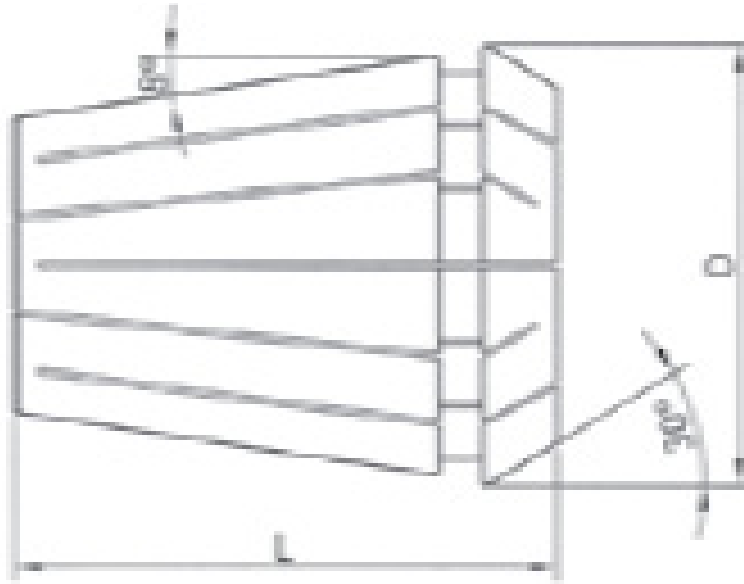

ER 11 CLASS 2

Sip. No.	Sıkma Çapı Ømm
ER110102	1.0-0.5
ER110152	1.5-1.0
ER110202	2.0-1.5
ER110252	2.5-2.0
ER110302	3.0-2.5
ER110352	3.5-3.0
ER110402	4.0-3.5
ER110452	4.5-4.0
ER110502	5.0-4.5
ER110552	5.5-5.0
ER110602	6.0-5.5
ER110652	6.5-6.0
ER110702	7.0-6.5
ER110752*	7.5-7.3
ER110802*	8.0-7.8