

## SEPARATÖR - TİKAÇ - REKORLAR

## TİKAÇLAR - SEPARATÖR

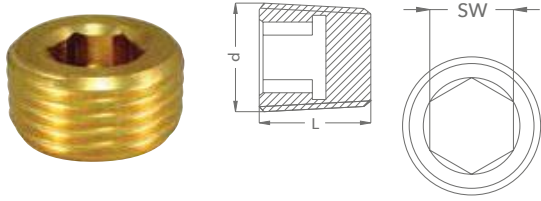

Sip. No.	d	L	SW
KTP 10	BSP 1/8"	8	5
KTP 13	BSP 1/4"	10	7
KTP 17	BSP 3/8"	10	8
KTP 21	BSP 1/2"	10	10
KTP 26	BSP 3/4"	12	12
KTP 33	BSP 1"	19	17
KTP42	BSP 1.1/4"	22	22
KTP48	BSP 1.1/2"	22	24

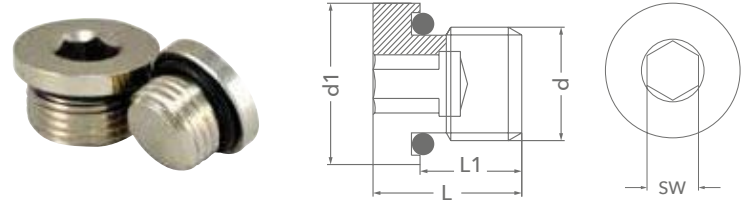

Sip. No.	d	d1	L	L1	SW
OSKTR M10	M10x1	14	10	7	5
OSKTR M12	M12x1.5	17	11	8	6
OSKTR M14	M14x1.5	19	12	9	8
OSKTR M16	M16x1.5	21	12	9.5	10
OSKTR M22	M22x1.5	27	13	11.5	14
OSKTR M24	M24x1.5	30	15	11.5	14

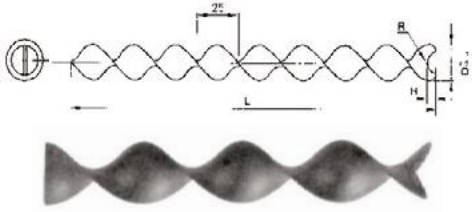

D1	D2	T	Ürün Sip. No.	D	L
6	15	1.2	GCT	8	25-30-35-40
8	18	1.5		10	
10	22	1.6		12	
13	25	2		16	
17	30	2		20	
22	35	2.4		25	

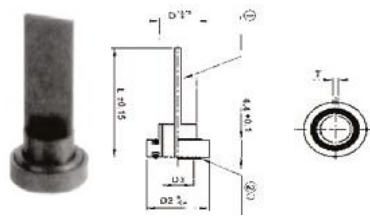

R	H	Sip. No.	D	L
2	2	GCB	8	96-196-296
2.5	2.5		10	
3	3		12	
4	4		16	
5	5		20	
6	6		25	

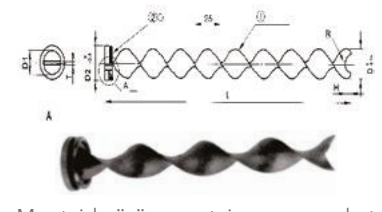

Montajda ürün montaj yuvasına rahat  
(0.2-0.5) boşlukla geçmelidir.

D1	D2	T	R	H	Ürün Sip. No.	D	L
8	15	1.5	2	2	GCA	8	100-200-300
10	18	1.8	2.5	2.5		10	
11	22	2	3	3		12	
15	25	3	4	4		16	
18	30	3	5	5		20	
22	35	3.5	6	6		25	

## VİTON ORİNGLİ TİKAÇ

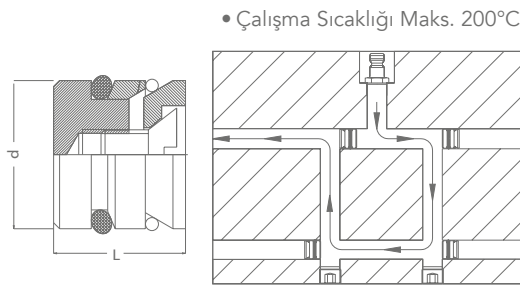

Viton Oring Sip. No.	Nbr Oring Sip. No.	d	L
TKV-06	TK-06	6	10
TKV-08	TK-08	8	10
TKV-10	TK-10	10	10
TKV-12	TK-12	12	10
TKV-14	TK-14	14	12
TKV-16	TK-16	16	12
TKV-20	TK-20	20	12

## OTOMATİK GİRİŞLİ REKORLAR (QUICK)

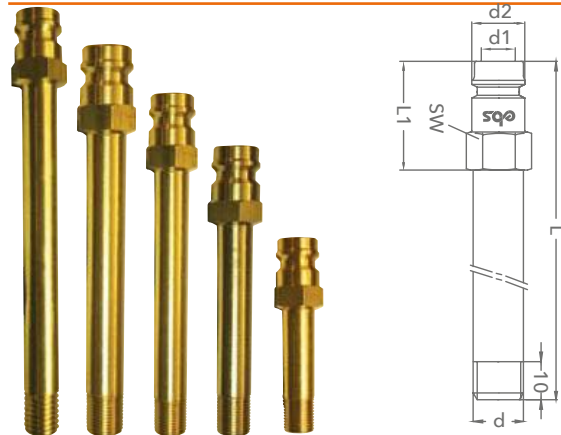

Valfsiz Sip. No.	d	d1	d2	SW	L	L1
590 ER 10	BSP 1/8"	9	13	14	29	10
590 ER 13	BSP 1/4"	9	13	14	29	10
590 ER 17	BSP 3/8"	9	13	17	29	10
590 ER 21	BSP 1/2"	9	13	21	29	10

Valfsiz Sip. No.	d	d1	d2	SW	L	L1
590 ER M8	M8x1.25	9	13	14	29	10
590 ER M10-1	M10x1.5	9	13	14	29	10
590 ER M10	M10x1.0	9	13	14	29	10
590 ER M12	M12x1.75	9	13	14	29	10
590 ER M14	M14x1.5	9	13	21	29	10
590 ER M16	M16x1.5	9	13	21	29	10
590 ER 10-60	BSP 1/8"	9	13	14	60	20
590 ER 10-80	BSP 1/8"	9	13	14	80	20
590 ER 10-100	BSP 1/8"	9	13	14	100	20
590 ER 10-120	BSP 1/8"	9	13	14	120	20
590 ER 10-150	BSP 1/8"	9	13	14	150	20
590 ER 13-60	BSP 1/4"	9	13	14	60	20
590 ER 13-80	BSP 1/4"	9	13	14	80	20
590 ER 13-100	BSP 1/4"	9	13	14	100	20
590 ER 13-120	BSP 1/4"	9	13	14	120	20
590 ER 13-150	BSP 1/4"	9	13	14	150	20
590 ER 17-60	BSP 3/8"	9	13	17	60	20
590 ER 17-80	BSP 3/8"	9	13	17	80	20
590 ER 17-100	BSP 3/8"	9	13	17	100	20
590 ER 17-120	BSP 3/8"	9	13	17	120	20
590 ER 17-150	BSP 3/8"	9	13	17	150	20