

SIFIRLAMA MASTARI

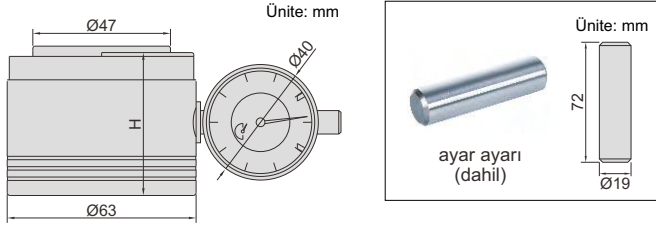

Kod	Yükseklik (H)	Doğruluk	Test yükü
6556-50	50mm	±10µm	10N (50mm'de)



6556-50

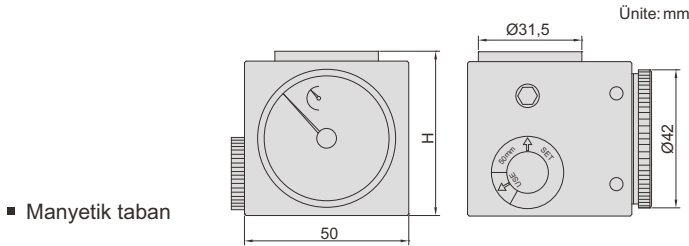
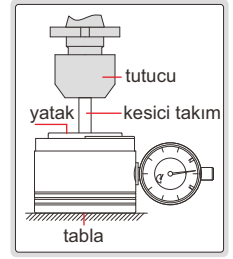

- Manyetik taban

Kod	Yükseklik (H)	Doğruluk	Test yükü
2397-502A	50mm	±10µm	9N (50mm'de)



2397-502A

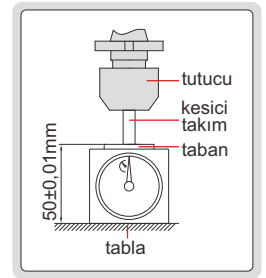

SAATLİ SIFIRLAMA APARATI

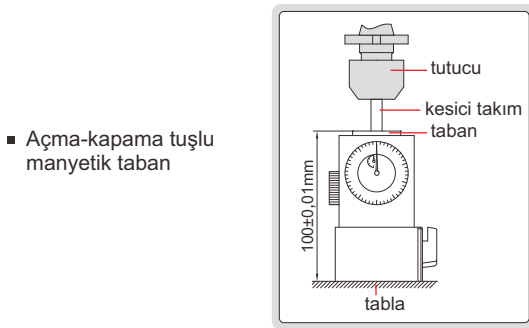

- Açma-kapama tuşlu manyetik taban

Kod	Yükseklik (H)	Doğruluk	Test yükü
2394-100A	100mm	±10µm	9N (100mm'de)



2394-100A

SAATLİ SIFIRLAMA APARATI

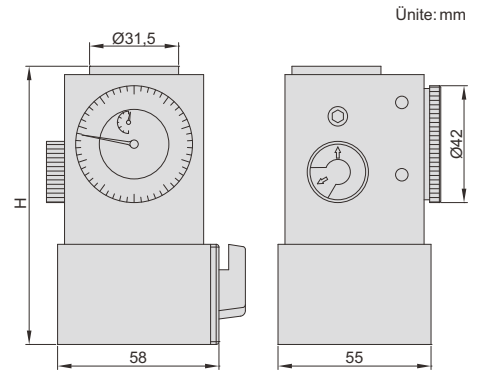

DÜŞÜK TEST YÜKÜ SIFIRLAMA MASTARI

INSIZE PLUS
AVRUPA'DA ÜRETİLMİŞTİR

DÜŞÜK
TEST YÜKÜ



6555-100B

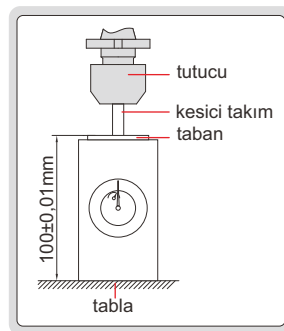

- Manyetik taban
- Düşük test yükü, çapı en az Ø0,1mm olan mikro aletler için uygundur

Kod	Yükseklik (H)	Doğruluk	Test yükü
6555-100B	100mm	±10µm	1N (100mm'de)