

DİJİTAL YATAY KUMPAS

BİLGİ ÇIKIŞI



7101-300A



7101-400A

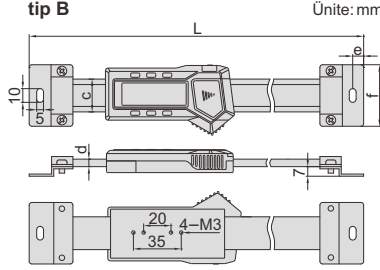
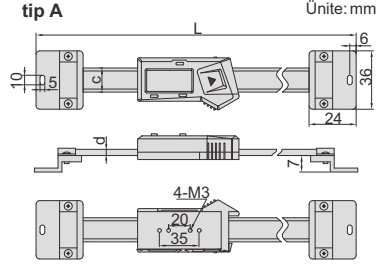

uygulama örneği

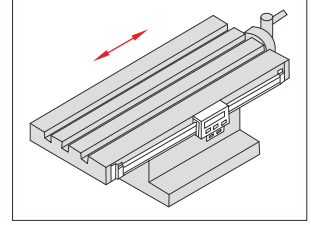

- Hassasiyet: 0,01mm/0,0005"
- A tipi tuşlar: on/off, sıfırlama, mm/inç,
B tipi tuşlar: on/off, sıfırlama, mm/inç, ABS, veri ön ayarı
- Otomatik kapanma ve dijital üniteyi hareket ettirerek açma
- CR2032 Lityum PİL
- Bilgi çıkışı
- Paslanmaz çelikten imal edilmiştir
- Monte edilebilmesi için braket ile tedarik edilir

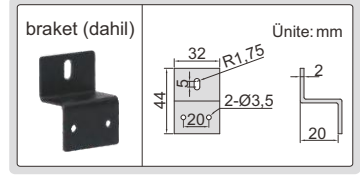

Veri arayüzü ile
(veri çıkış kablosu kod 7315-21, 7302-21, opsiyonel) (mm)

Kod	Ölçüm aralığı	Tip	Doğruluk	L	c	d
7101-100A	100mm	A	±0,02mm	215	16	4
7101-150A	150mm	A	±0,03mm	265	16	4
7101-200A	200mm	A	±0,03mm	315	16	4
7101-300A	300mm	A	±0,04mm	445	16	4

Veri arayüzü ile
(veri çıkış kablosu kod 7315-22, 7302-22, opsiyonel) (mm)

Kod	Ölçüm aralığı	Tip	Doğruluk	L	c	d	e	f
7101-400A	400mm	B	±0,05mm	590	24	5,5	8	45
7101-500A	500mm	B	±0,05mm	690	24	5,5	8	45
7101-600A	600mm	B	±0,08mm	790	24	5,5	8	45
7101-800A	800mm	B	±0,10mm	990	24	5,5	8	45
7101-1000A	1000mm	B	±0,10mm	1240	31	10,5	10	60

13

DİJİTAL DİKEY KUMPAS

BİLGİ ÇIKIŞI

veri çıkış kablosu



7302-SPC7

uygulama örneği

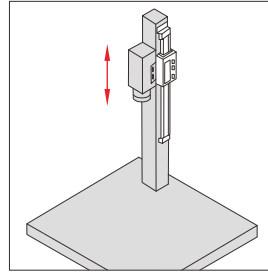

- Hassasiyet: 0,01mm/0,0005"
- Tuşlar: aç/kapa, ayar, mm/inç, ABS/INC, bilgi çıkışı, TOL, ayar
- PİL LR44, veri çıkışı
- Paslanmaz çelikten imal edilmiştir
- Monte edilebilmesi için braket ile tedarik edilir
- Opsiyonel aksesuar: veri çıkış kablosu (kod 7302-SPC7, klavye formatı)

Kod	Ölçüm aralığı	Doğruluk	B	C	D	E	F	L
7102-100	100mm/4"	±0,02mm	4	20	6	24	40	245
7102-150	150mm/6"	±0,03mm	4	20	6	24	40	296
7102-200	200mm/8"	±0,03mm	4	20	6	24	40	345
7102-300	300mm/12"	±0,04mm	4	20	6	24	40	445
7102-400	400mm/16"	±0,05mm	4	20	6	24	40	545
7102-500	500mm/20"	±0,05mm	5,5	24	8	32	45	685
7102-600	600mm/24"	±0,08mm	5,5	24	8	32	45	785
7102-800	800mm/32"	±0,10mm	5,5	24	8	32	45	985
7102-1000	1000mm/40"	±0,10mm	10,5	31	25	40	60	1245

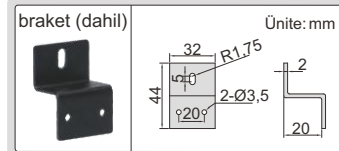
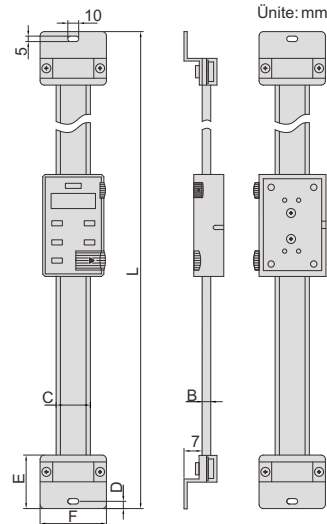

7102-300