

XZ-DÜZLEM TABLASI KOD 6587-60

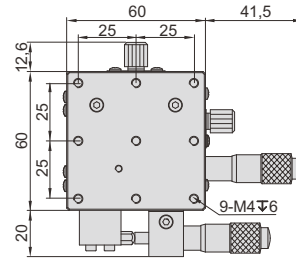

Ünite: mm

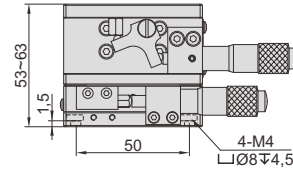
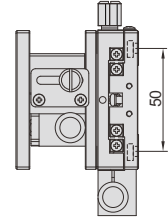

- Çapraz makaralı kızaklar, yüksek hassasiyet ve pürüzsüz hareket elde eder
- Tabla, Alüminyum alaşımından elde edilir

ÖZELLİK

Kod	X-düzlem değişimi	Z-düzlem değişimi	Mikrometre hassasiyeti	Maksimum yük	Tabla boyutu	Ağırlık
6587-60	±6,5mm	10mm	0,01mm	29,4N (3kgf)	60x60mm	0,51kg

12

XYZ-DÜZLEM TABLASI KOD 6585-60

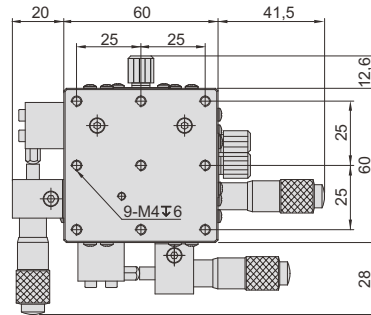
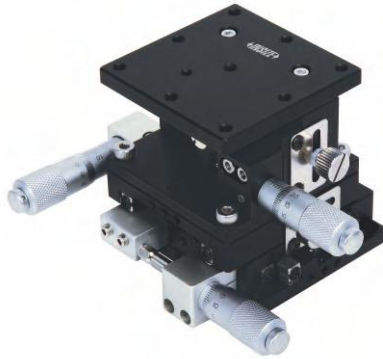

Ünite: mm

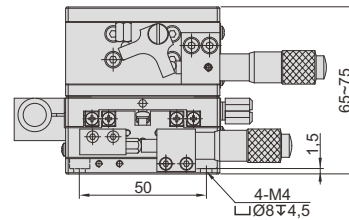
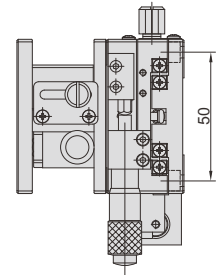

- Çapraz makaralı kızaklar, yüksek hassasiyet ve pürüzsüz hareket elde eder
- Tabla, Alüminyum alaşımından elde edilir

ÖZELLİK

Kod	XY-düzlem değişimi	Z-düzlem değişimi	Mikrometre hassasiyeti	Maksimum yük	Tabla boyutu	Ağırlık
6585-60	±6,5mm	10mm	0,01mm	29,4N (3kgf)	60x60mm	0,75kg